



Technical comercial data

CU-5.3 T.CU-6.3

Serie CUBETA – Versión 17-05-2023

TECHNICAL DATA:

Material: PP copolymer of first quality, suitable for contact with food according to current regulations.

Colours: White standard. Consult for other colours.

Useful Volume: 5 litres
Volume to the edge: 5.3 litres

Weight of the rectangular bucket: 169 g. approx.
Weight of the lid: 56 g. approx.
Weight of the handle (plastic): 6 g. approx.
Total Weight: 231 g. approx.



Design surface photographic finish: 145 x 620 mm (altura x perímetro).

MEASUREMENTS:

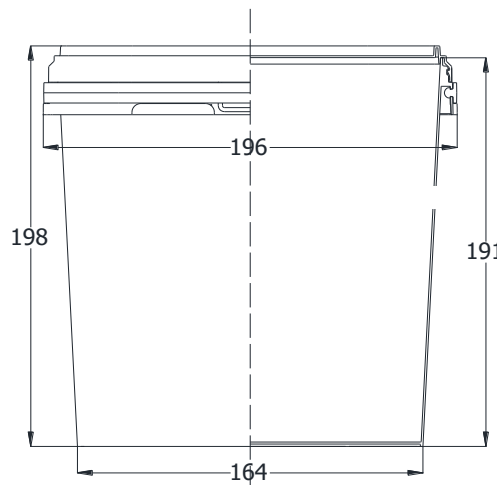

Measurements in millimetres

GROUPING OF TRANSPORT:

Rectangular buckets: 900 rectangular buckets per pallet
Pallet dimensions: 1180 x 979 x 1113 (see drawing)

Lids: 180 lids per box, this serves as a packaging of transportation

Box dimension: 445 x 210 x 915

